

# TAVOLO The Ultimate Space Saver

## Wall mount: Installation instructions

Congratulations, you've purchased the innovative wall mounting TAVOLO Table Bar, by H.E. Nelson Inc. You will soon be enjoying your new attractive and space conscience table after this quick installment. We thank you for your purchase and please check back with the retailer or our web site [www.tavololine.com](http://www.tavololine.com) for attachments and different models.

**Step 1** | Gather your parts and tools (Phillips head screw driver and a hammer).

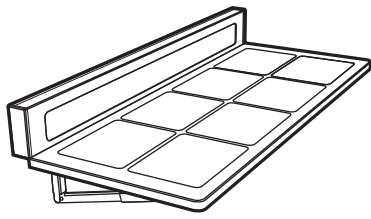
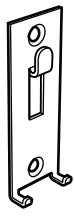

Table x 1



Mounting hooks x 3



Mounting screws x 6



Anchors x 6



Installation template\* x 1 (\*Printed on the outside of the box.)

**Step 2** | Working with the template.

Cut the template from the outside of the box. Tape the template on the wall and poke holes in the center of the mounting holes to mark the screw locations. Note: The table comes with anchors suitable for drywall. The table can mount to any vertical wall, consult your local hardware store for the correct hardware.

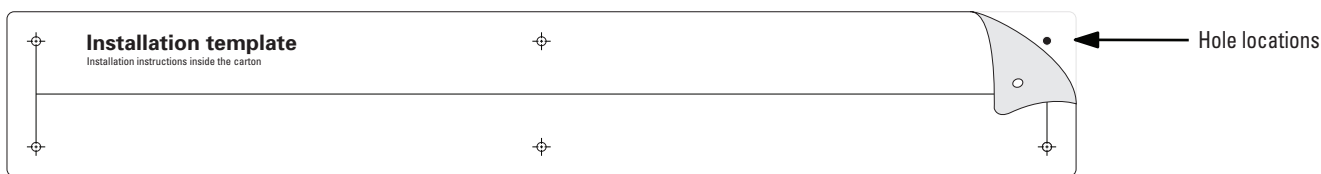

**Step 3** | Secure the wall anchors

Now that you have marked the hole locations on the wall, you need to secure the anchors and the mounting hook.

**A** Tap Hole (Drive screw in and then remove it to create hole)

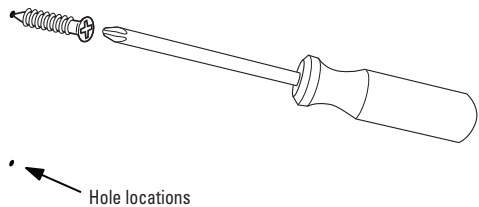

**B** Hammer in the anchors

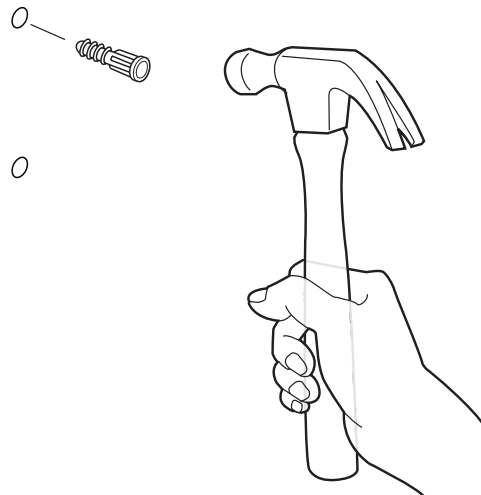

**C** Mount the brackets

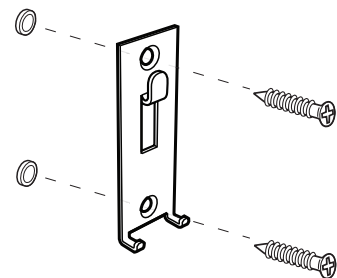

**Step 4** | Attaching the table

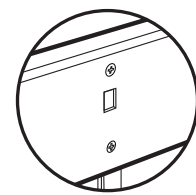
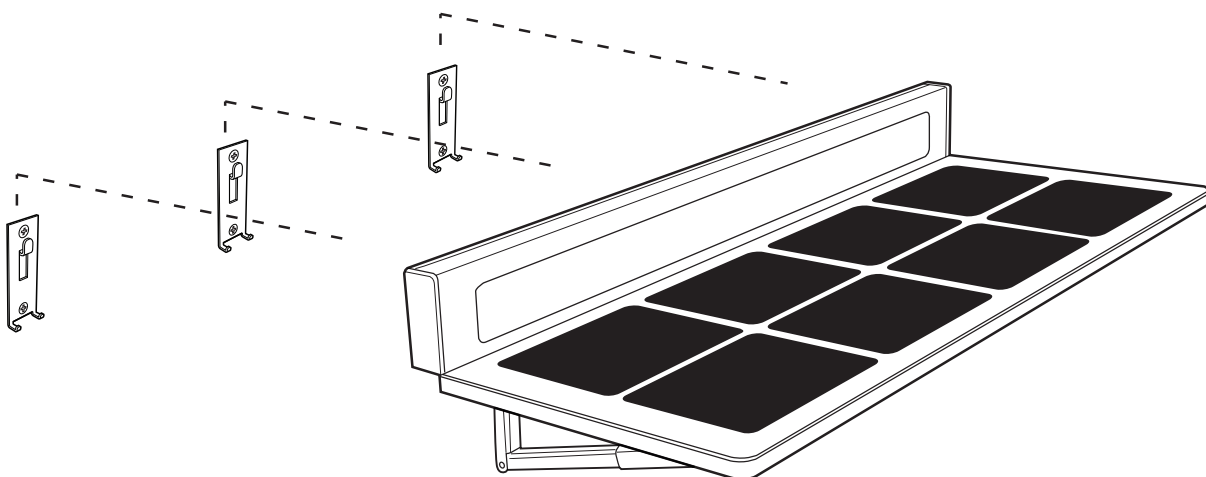

Align the hooks with the mounting holes on the back of the table.

For full information on the Tavolo 1 year limited warranty, log onto [www.tavololine.com/warranty](http://www.tavololine.com/warranty)



More information and installation videos are available at [www.tavololine.com/installation](http://www.tavololine.com/installation)



Questions, comments or feedback, email us at [info@tavololine.com](mailto:info@tavololine.com)